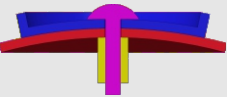
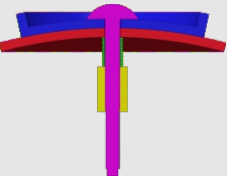
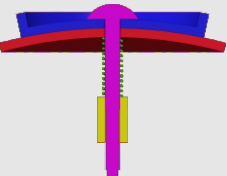
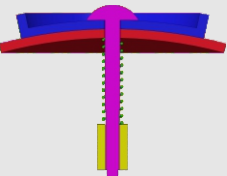

How to tighten the screws

Find your model in the table

Assembly section	Tightness	Models
	tight (no spring)	#61,#75
	tight (spring in green) (Short screw is recommended)	#72,#73,#77,#87,#88 #89
	medium (spring in green)	#94,#93,#90,#86,#85 #83,#82,#81,#80,#79 #78,#76,#71,#70,#69 #68,#67,#66,#65,#64 #63,#62,#60,#59
	loose (spring in green)	Mostly applicable to 'medium' category. Not recommended in general.

1. Tighter is usually better since the spring we provide is soft.
2. Early products had been using longer screws. You can either insert thick washer when necessary or request for short screws in the <Accessory & free parts> directory at our homepage:
<https://www.verypuzzle.com>

VeryPuzzle
2024/04

VeryPuzzle

9th Megaminx Ball

D9

#73

500+ parts
12 axes



1

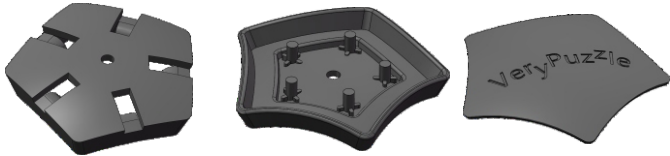

180051
180054
12X

190061
12X

190051
12X



60x

12x

12x

12x

screw tension

no tension 0 1 2 3 4 5 6 7 8 9 tight

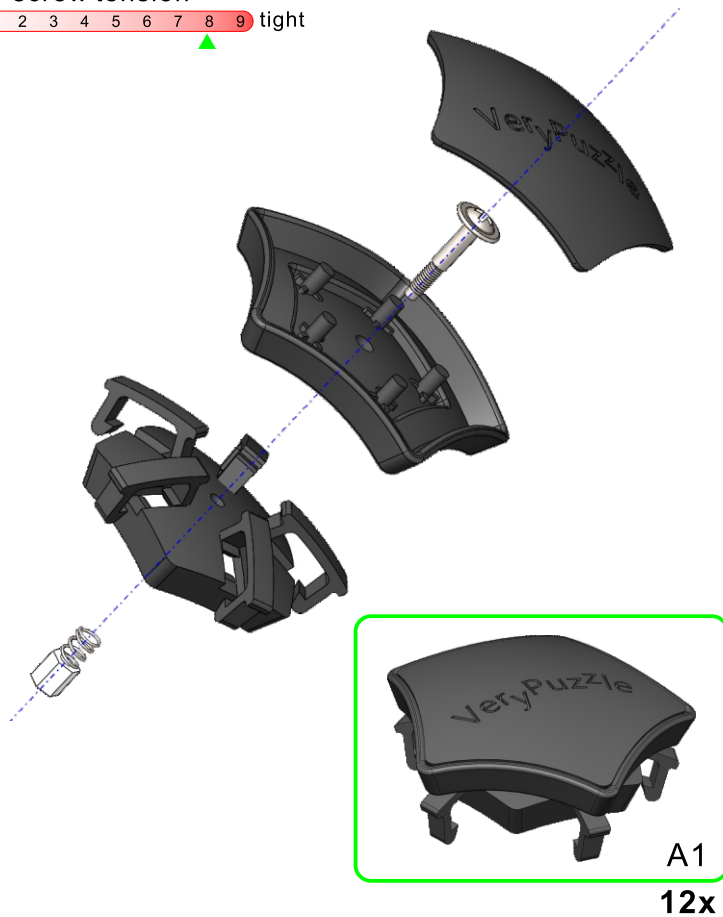

A1
12x

2



A1 12x

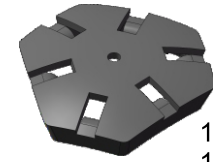

180052
180053
20X



30x

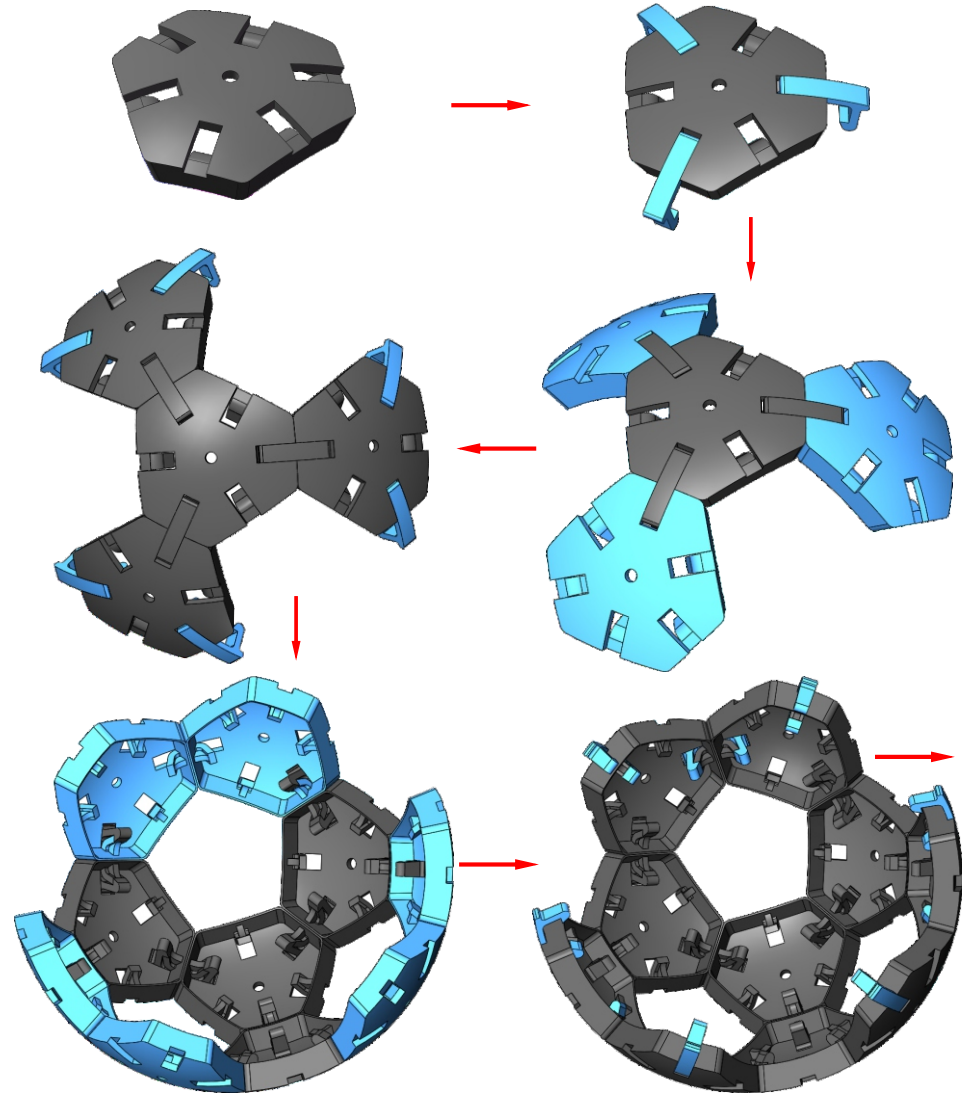

2

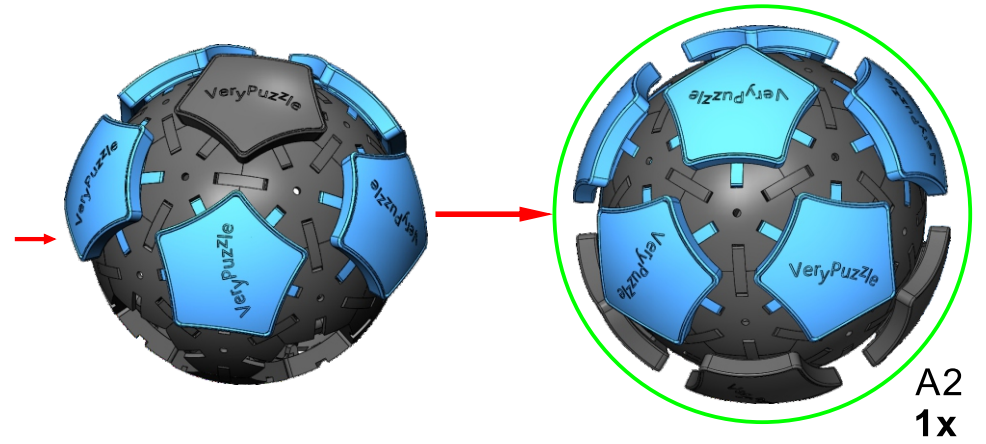
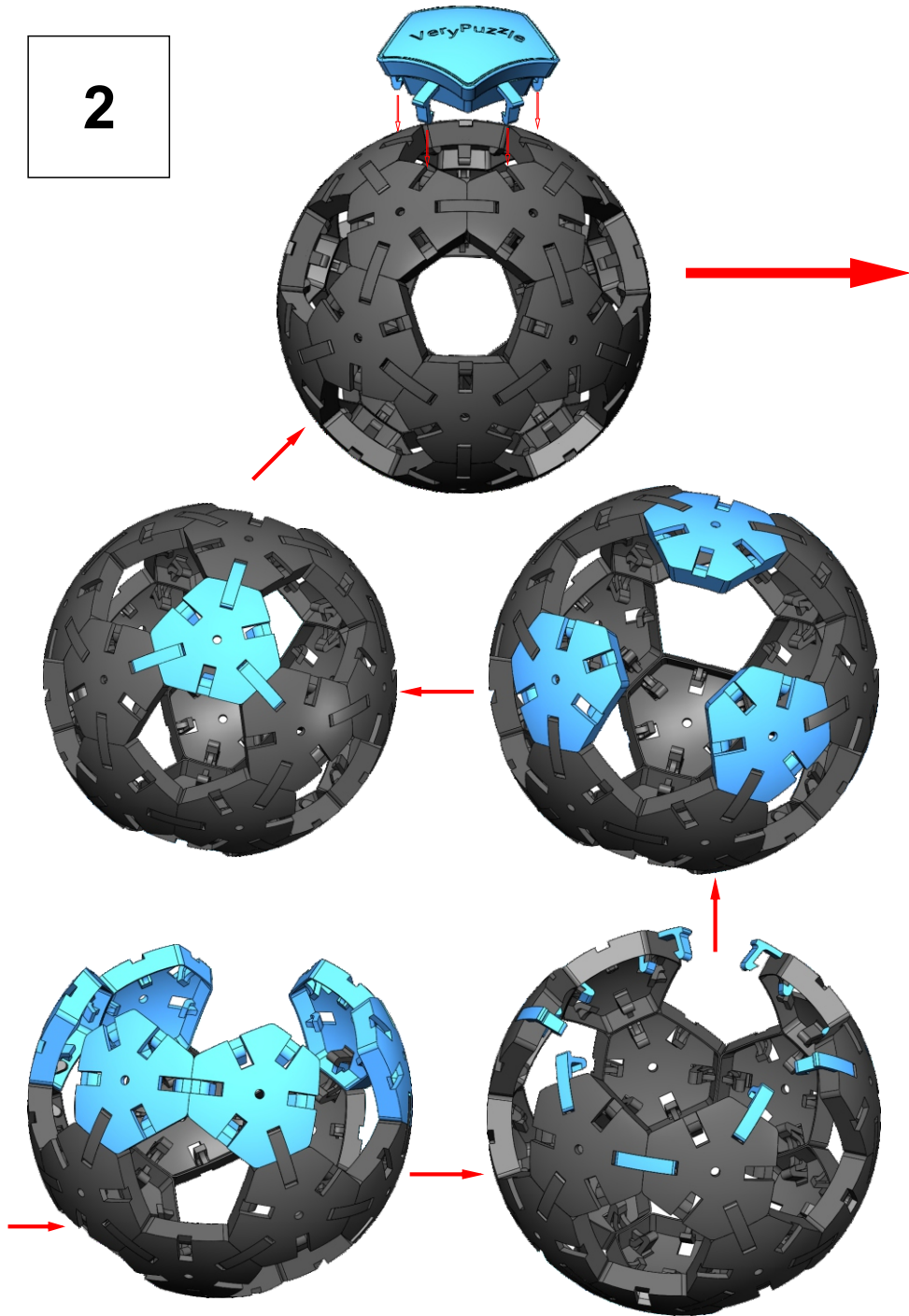

3

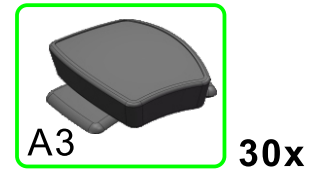
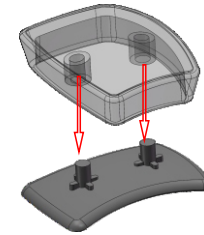
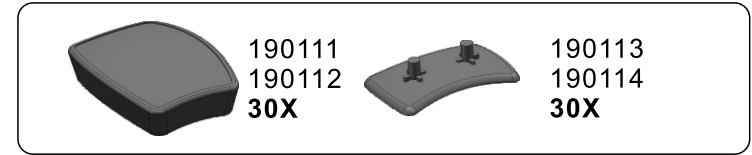

4

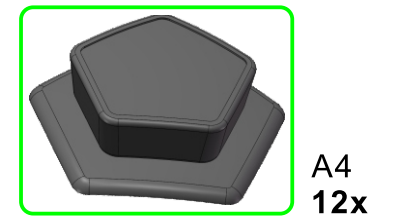
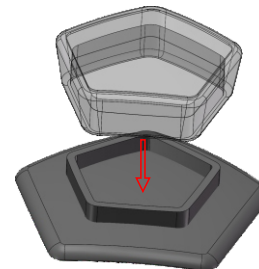

5



190532
30X

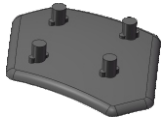

190531
30X

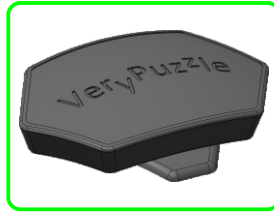
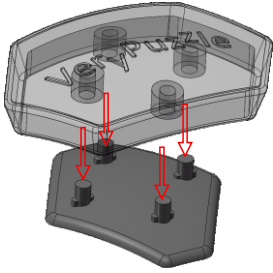

A5
30x

6



190551
190552
60X

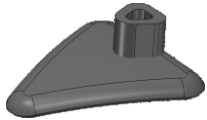

190553
190554
60X

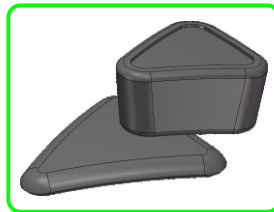
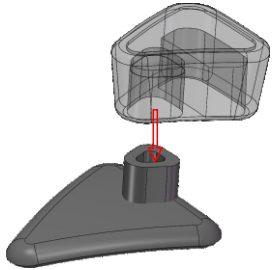

A6
60x

7

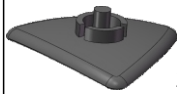

190091
190092
20X



190093A2
190094A2
20X



190561
190562
20X

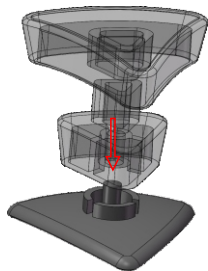

A7
20x

8

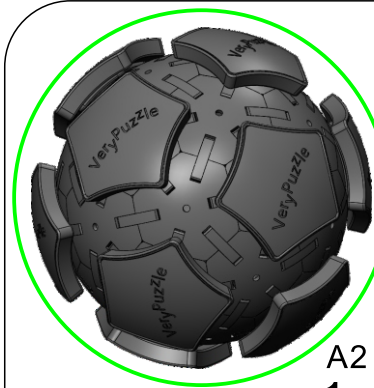

A2
1x



A5
30x

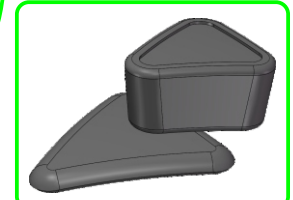

A6
60x

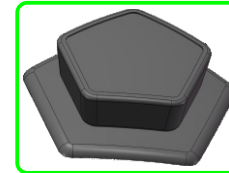

A4 12x

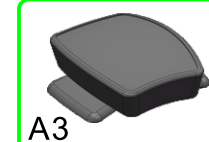

A3
30x



A7
20x

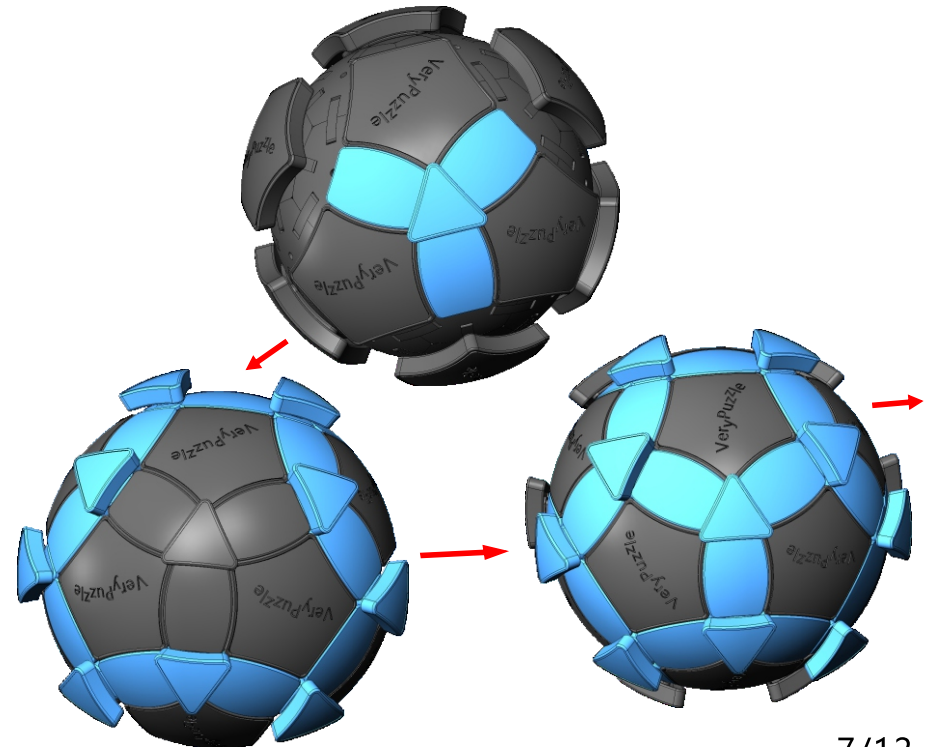

8

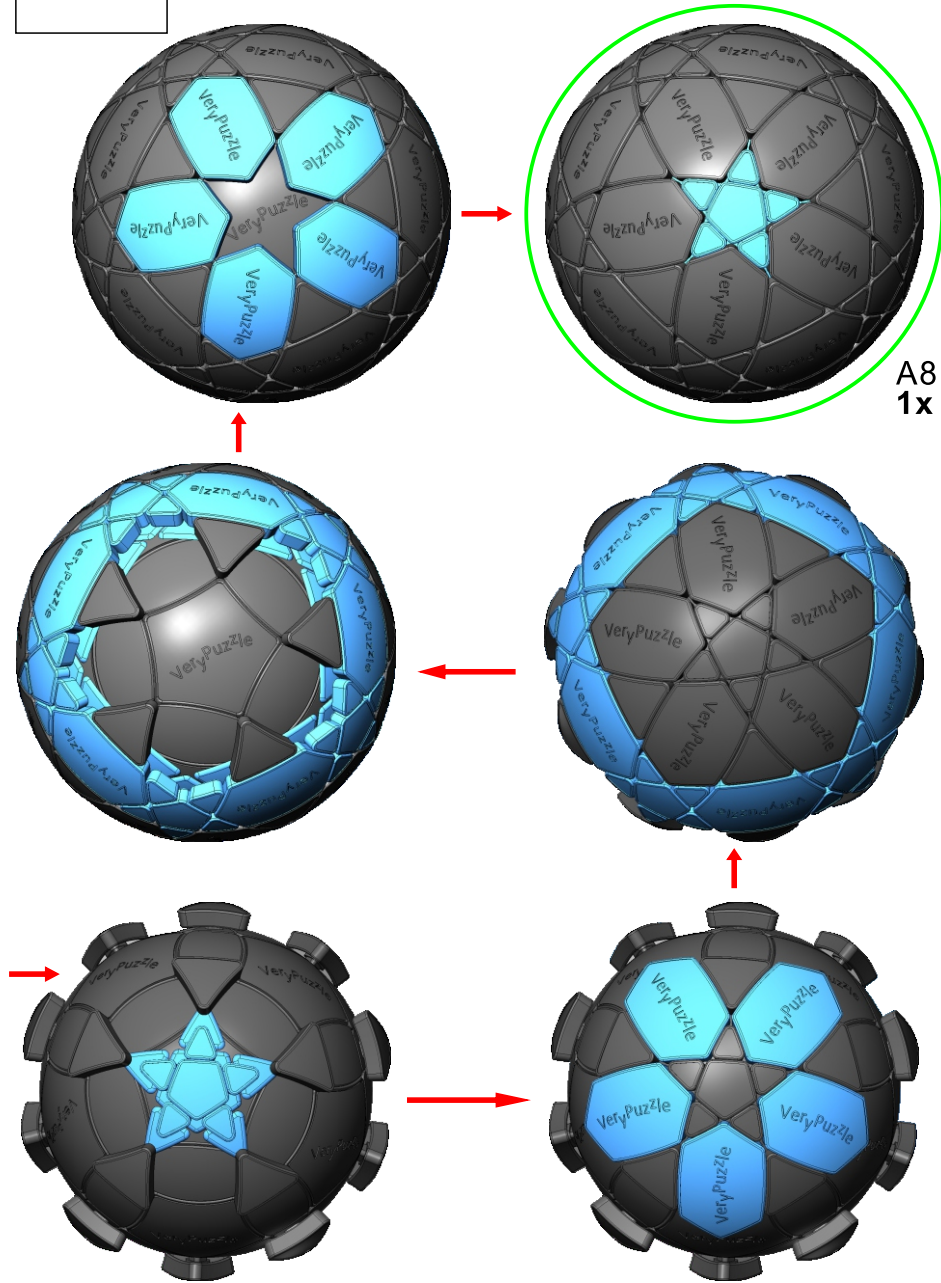

A8
1x

9

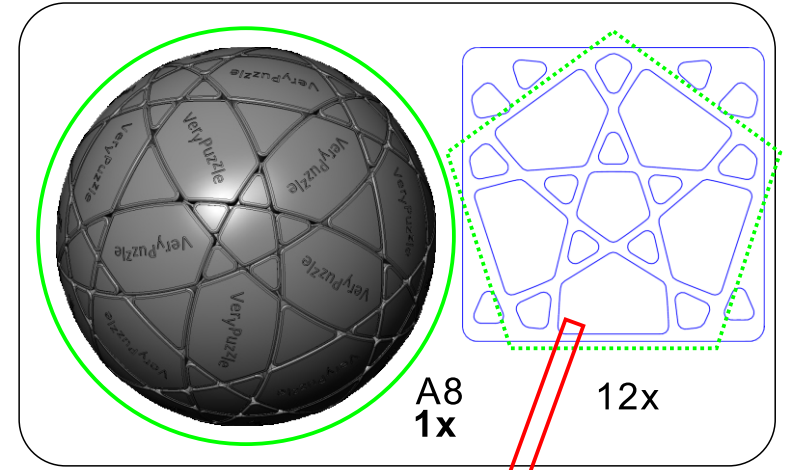

A8
1x

12x

Clean part surface
before applying stickers

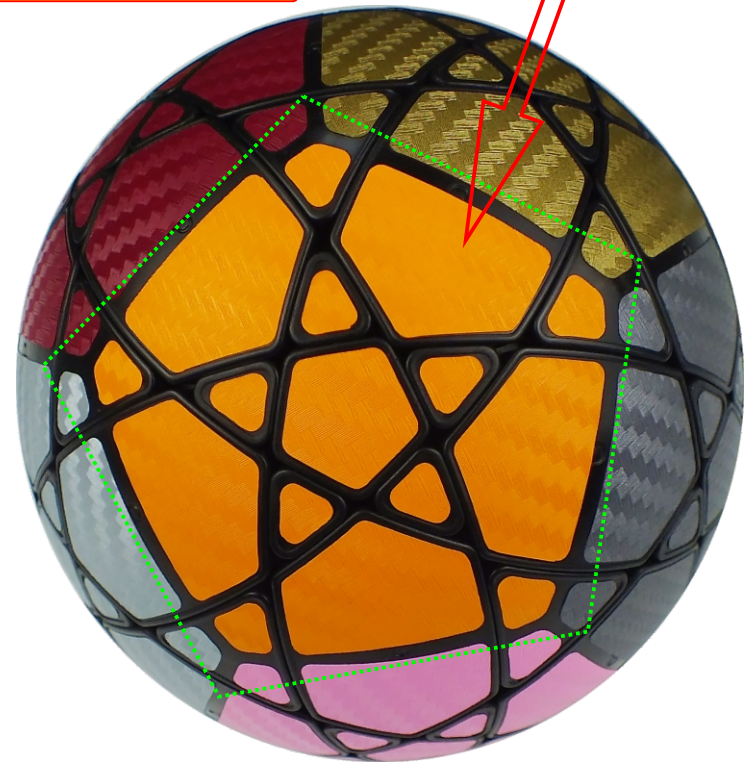

10

Rotation Rules

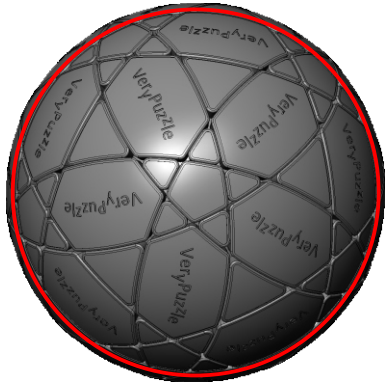

5-fold symmetry
Turns $72 \cdot n$ degrees

Notations and Algorithms

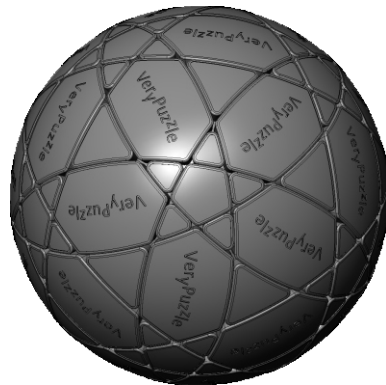
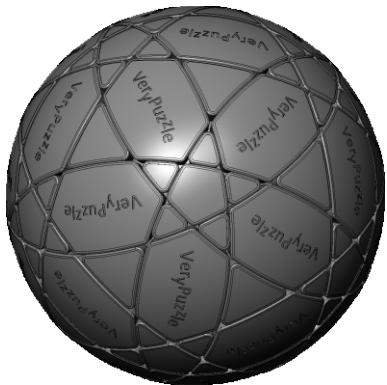

Product Information Card

Product Name	9TH Megaminx Ball
Model NO.	#73
Design	VeryPuzzle Co., Ltd(HK)
Manufacturer	VeryPuzzle Co., Ltd(HK)
Year of release	2019
Maximum diameter	95 mm
Visible moving parts	122 pcs
Coloring strategy	Voronoi
Number of colors	12 colors
Sticker type	textured
Sticker protection	Yes
Number of sticker pieces	192 pcs
Axis & Symmetry	D(C5)
Maximum parts shared between two axes	9 parts
In-core spring	Yes
Adjustable tension	No
Technical Name	D9
Topological Print	D72
Core specification	DI80



180051
180054
12X

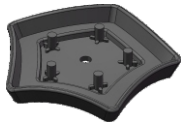

190061
12X



190111
190112
30X

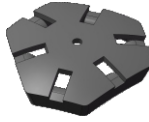

180052
180053
20X



190051
12X

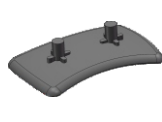

190113
190114
30X



190532
30X



190551
190552
60X



190541
12X

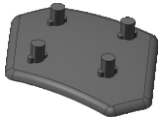

190531
30X

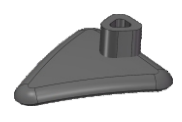

190553
190554
60X

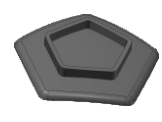

190542
12X



190621
1X



190093A2
190094A2
20X

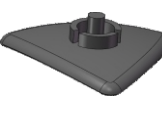

190091
190092
20X



200011
1X



190561
190562
20X



90X 12X 12X 12X

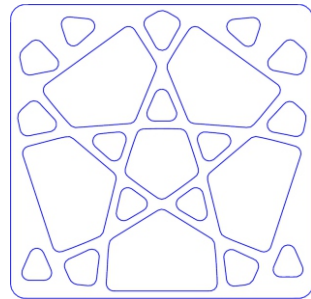

12X

Customer Service

1. support@verypuzzle.com



VeryPuzzle