

How to tighten the screws

1. It is always recommended to tighten the screws deep enough. The tighter the screws are, the more stable a puzzle will be (and probably more stiff while making turns).

2. Always leave a little bit of radial space along the screw so that the center cap can be lifted by around 1~2mm for single layered models.

**For those in-between models, like #65, #85, #88, #89, it is recommended to tighten further.

**For neat multiple layered models like #61, #75, #87, tighten the screws to their full depth.

3. Rules of thumb. Tension adjustment is in general dependent on personal judgement. Different tension could result in very different feel. Start with simple models and accumulate your own sense. Use different springs, screws, nuts if you think the default set can't provide your favorite handle.

4. Previous description of sticking screws out of nuts by 1-3mm is misleading in some cases and is not anymore recommended. Reason: the height of caps varies in different models.

VeryPuzzle
2021/08/06

VeryPuzzle



C103-M5

#86

200+ parts
14 axis



1

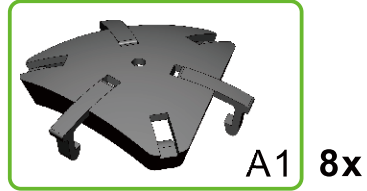
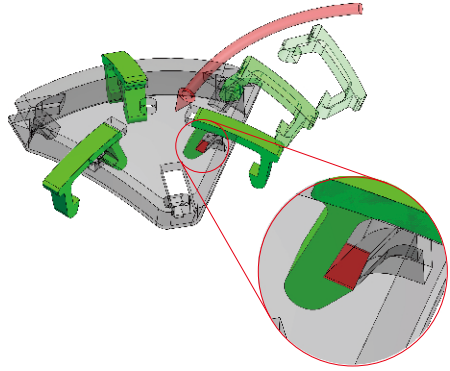
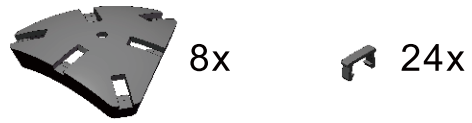

2

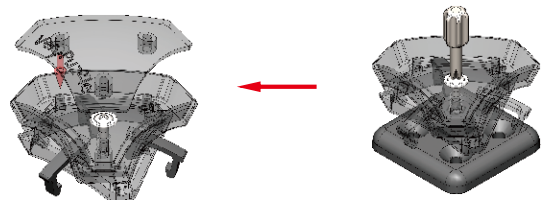
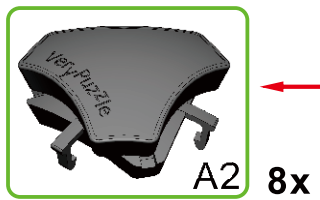
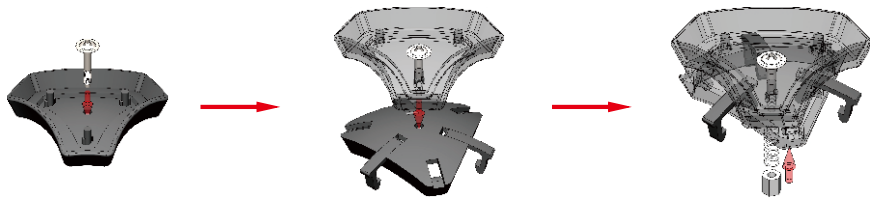
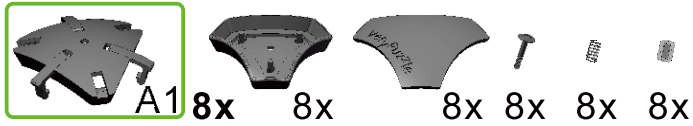

3

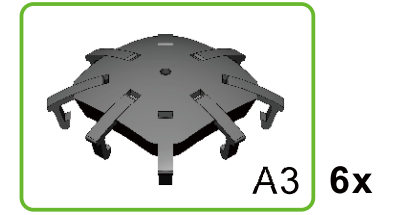
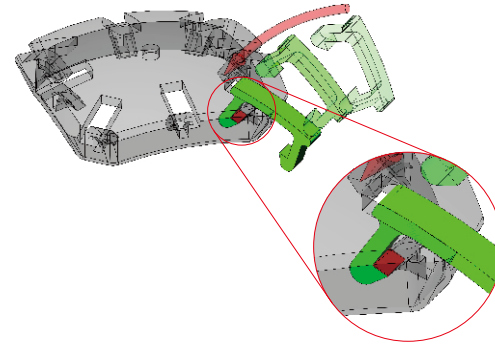

4

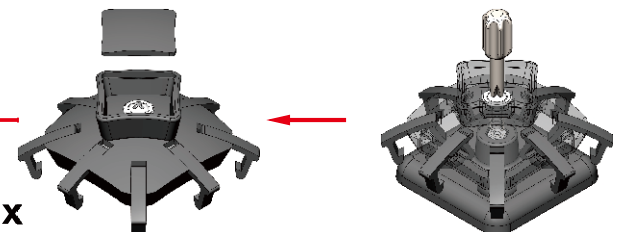
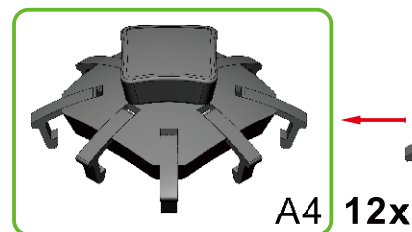
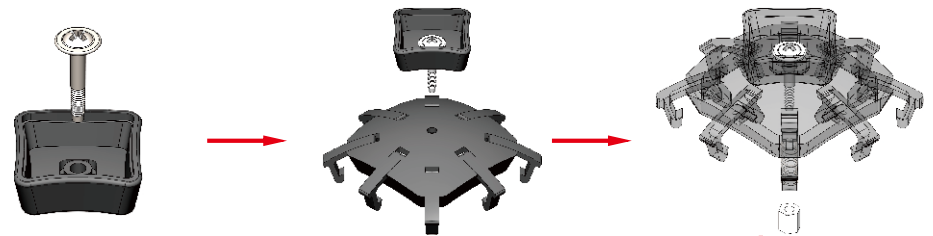
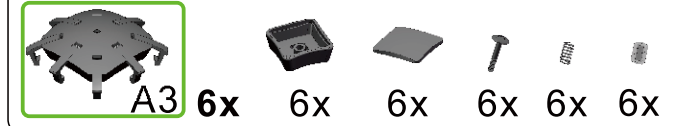

5



A2 8x



A4 6x

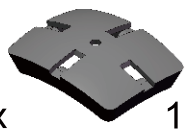

A5 12x

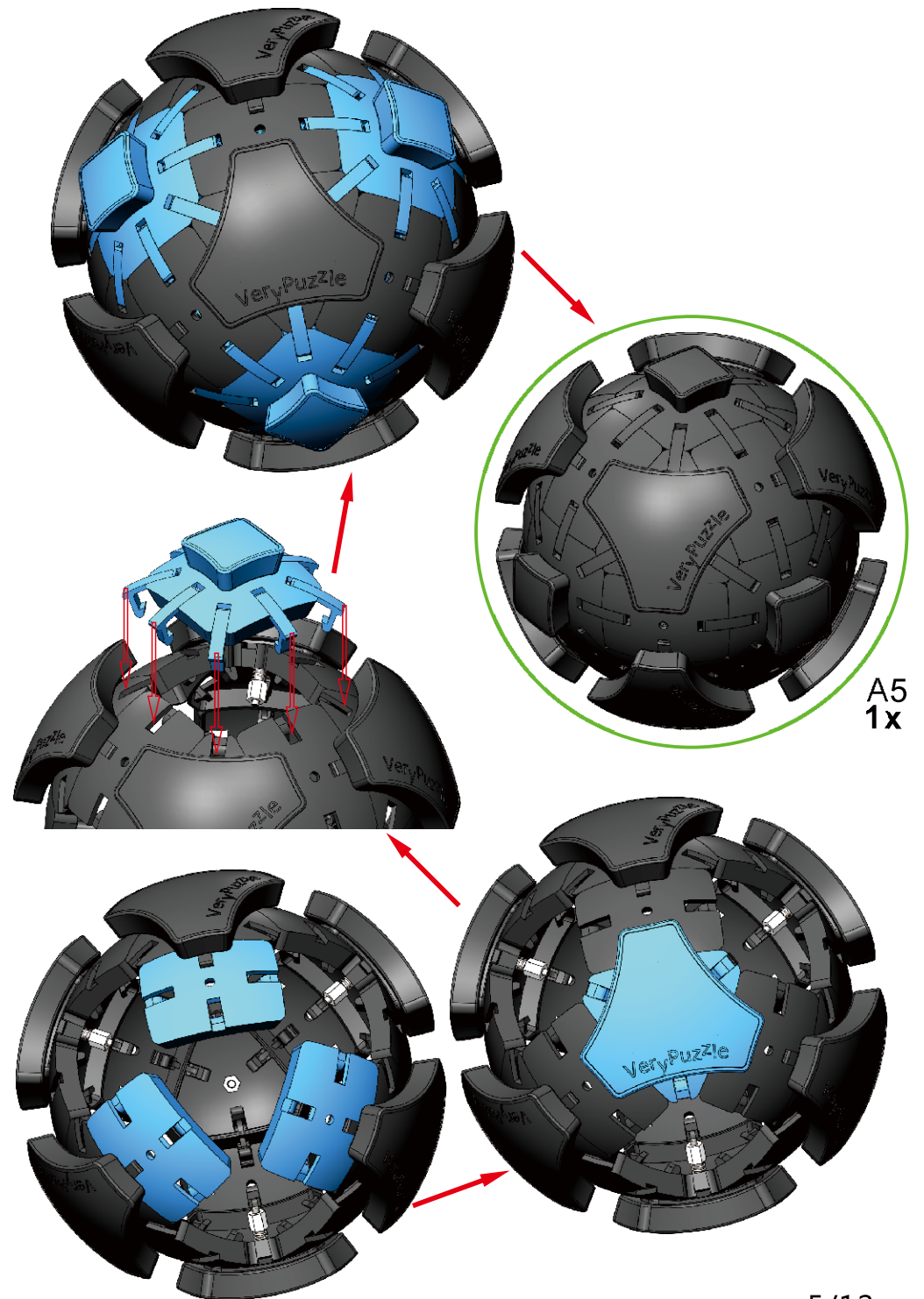
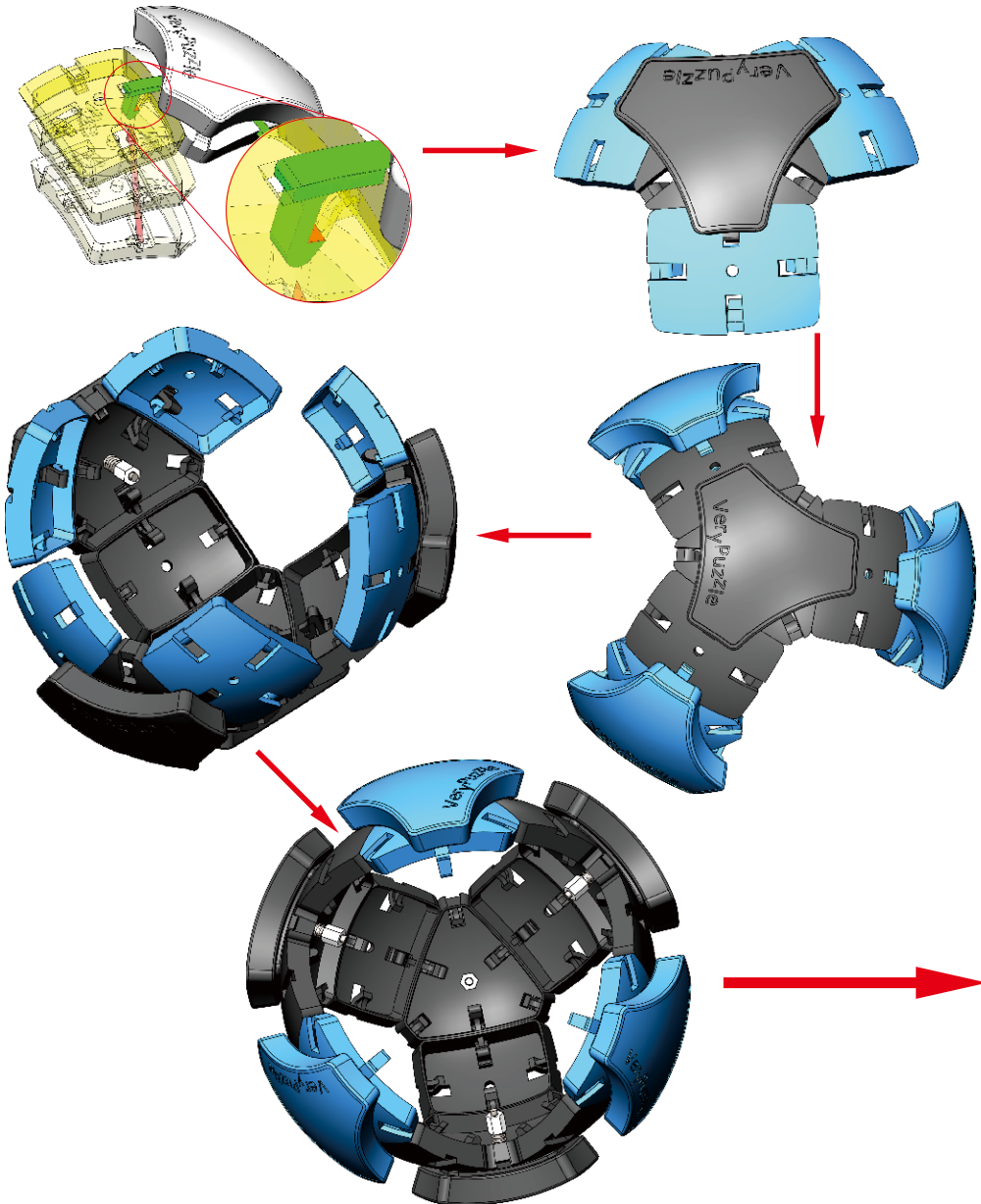

6

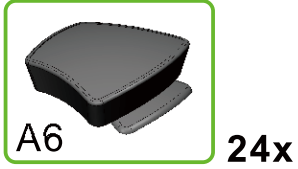
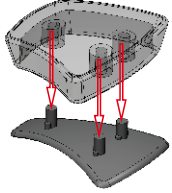
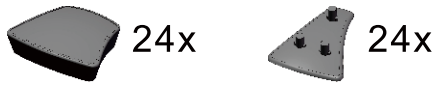

7

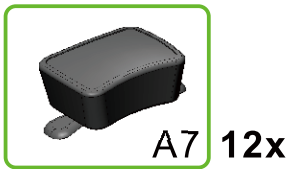
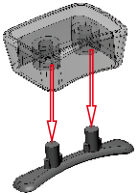

8

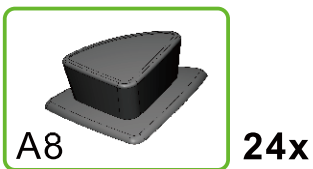
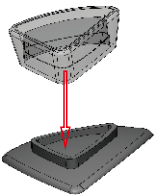

9

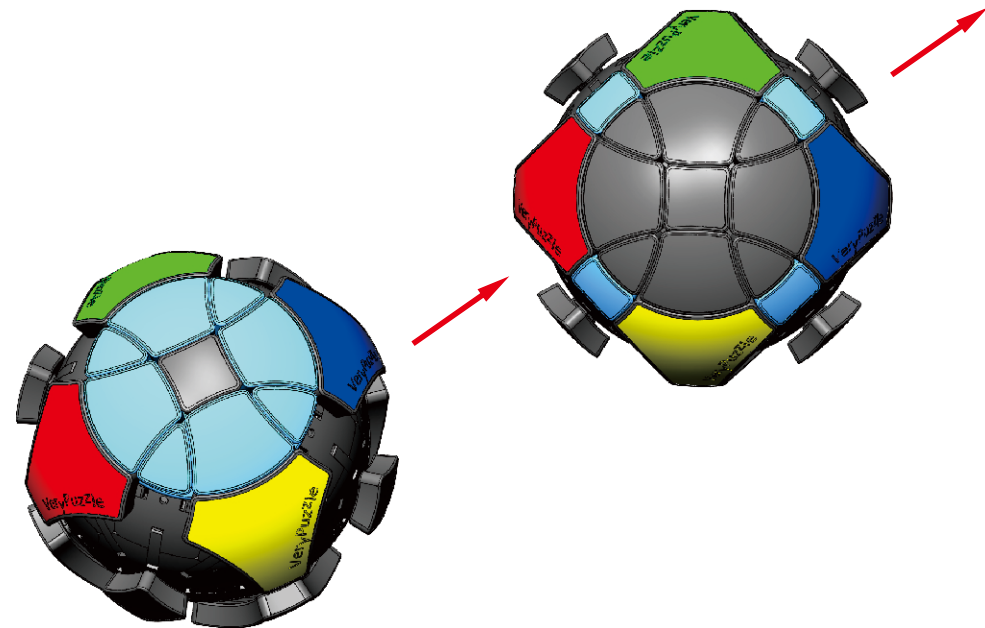
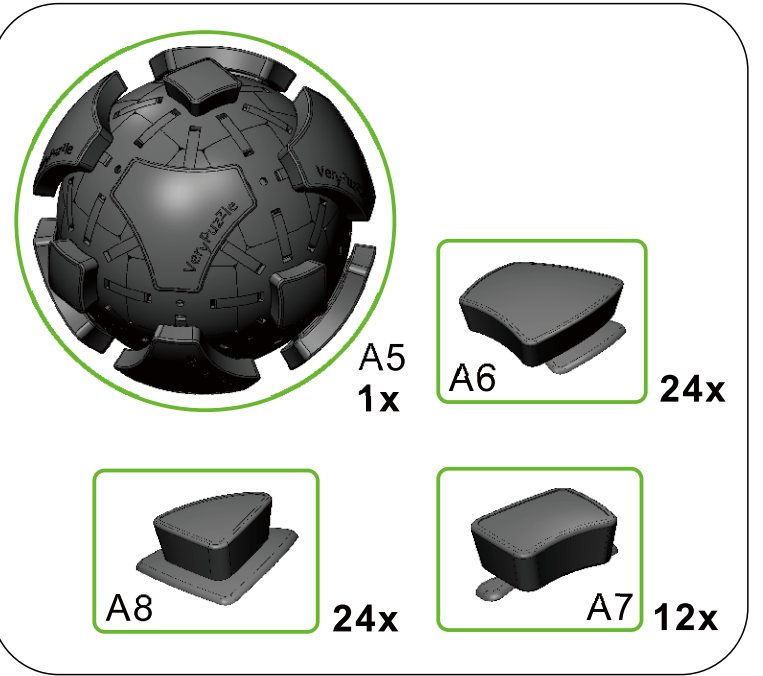

9

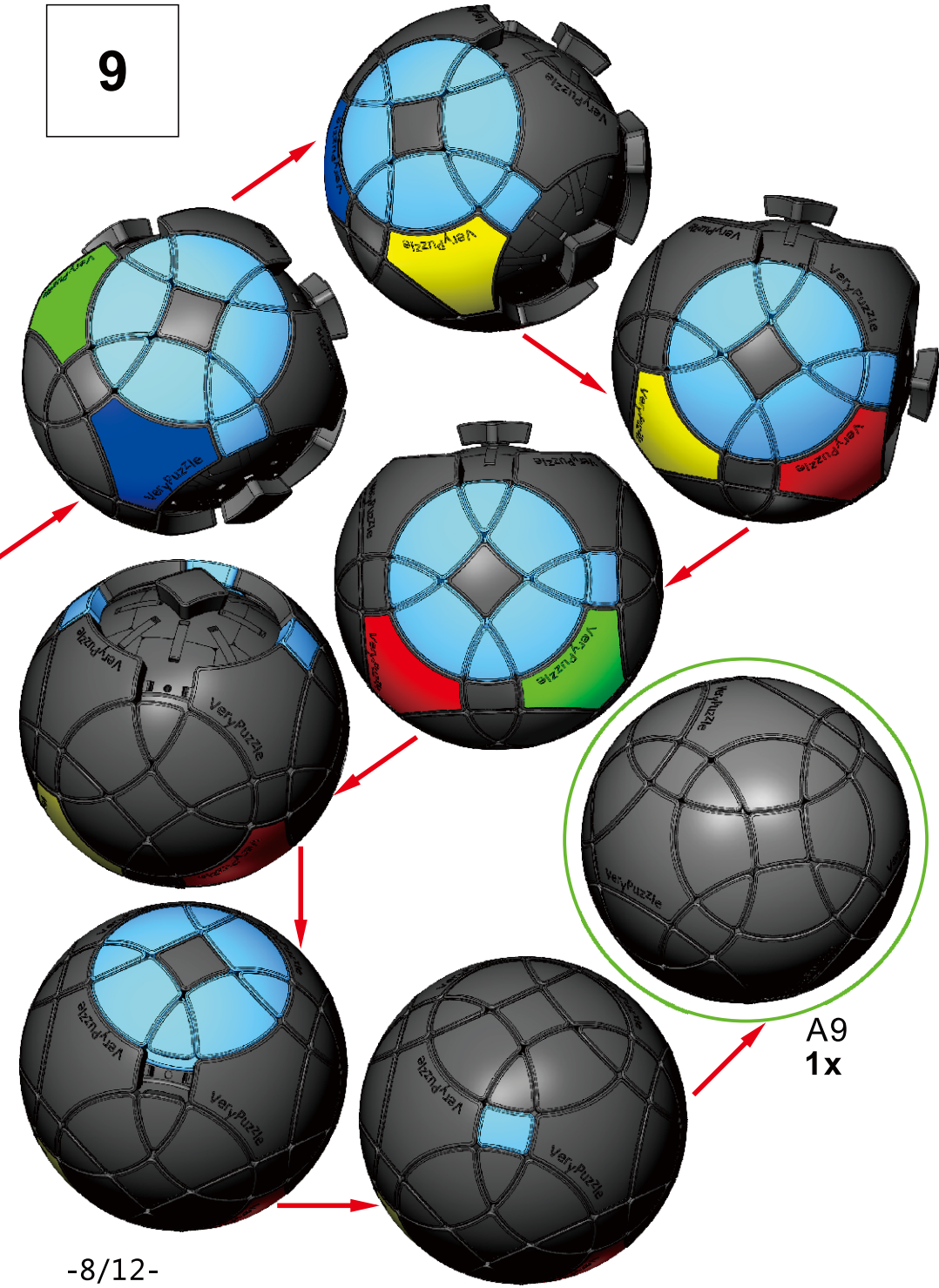

-8/12-

10

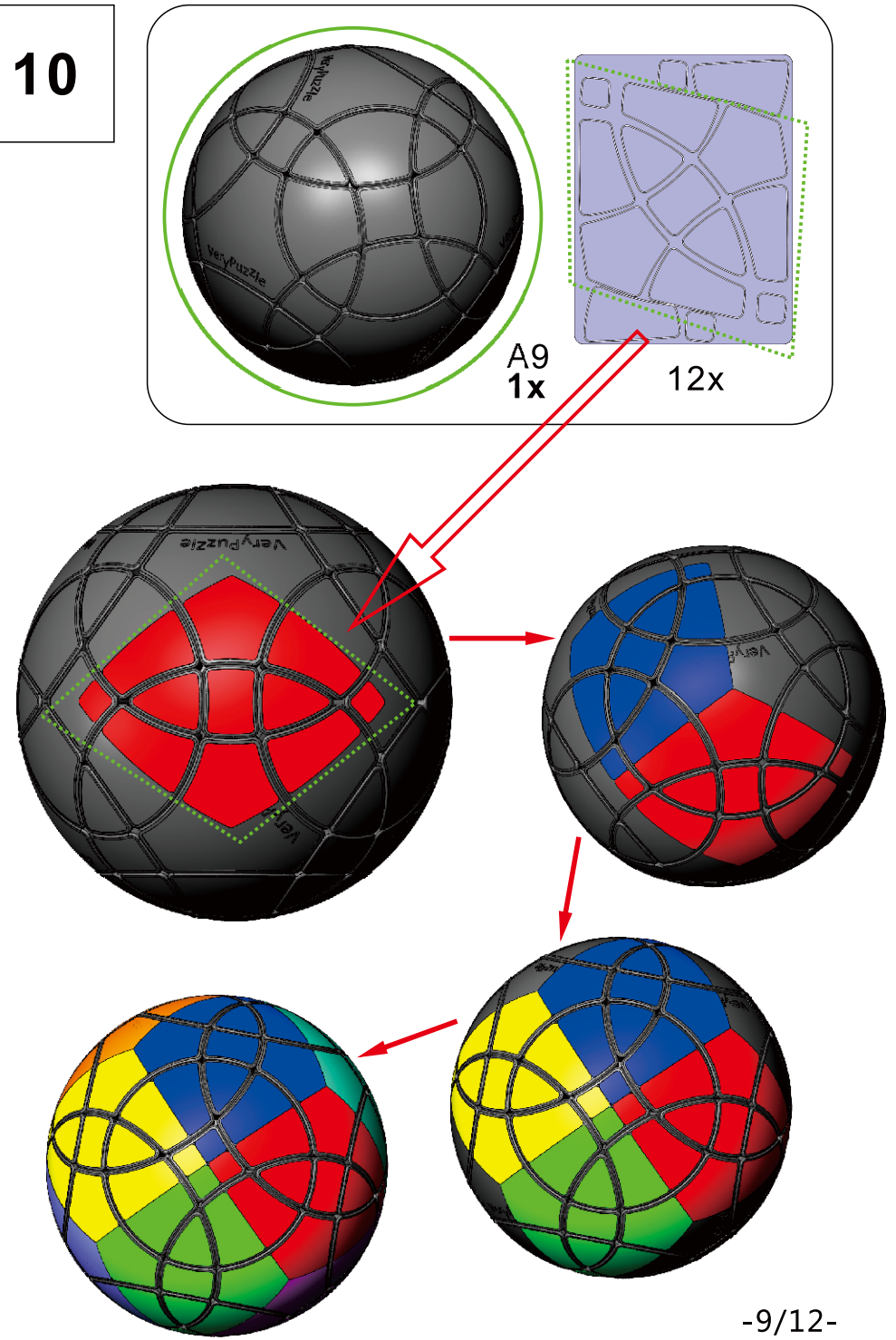

-9/12-

11

Rotation Rules

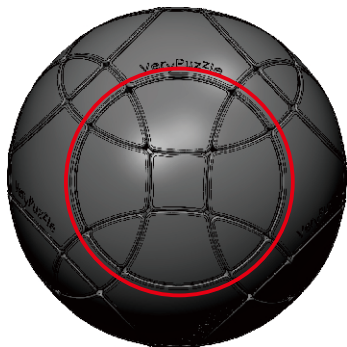

4-fold symmetry
Turns $90 \cdot n$ degrees



3-fold symmetry
Turns $120 \cdot n$ degrees

Notations and Algorithms



Product Information Card

Product Name	C103-M5
Model NO.	86
Design	VeryPuzzle Co., Ltd(HK)
Manufacturer	VeryPuzzle Co., Ltd(HK)
Date of release	2020/07/12
Maximum diameter	95 mm
Visible moving parts	74 pcs
Assembly challenge	★★★☆☆☆☆☆☆
Solving challenge	★★★☆☆☆☆☆☆
Stickers strategy	Voronoi, standard
Sticker material	Textured
Color scheme	12 colors
Sticker protection	Yes
Number of stickers	132 pcs
Axis & Symmetry	$C(O4)+O(O3)$
In-core spring	Yes
Adjustable tension	No
Topological Print	C35O45
Core specification	CORD80

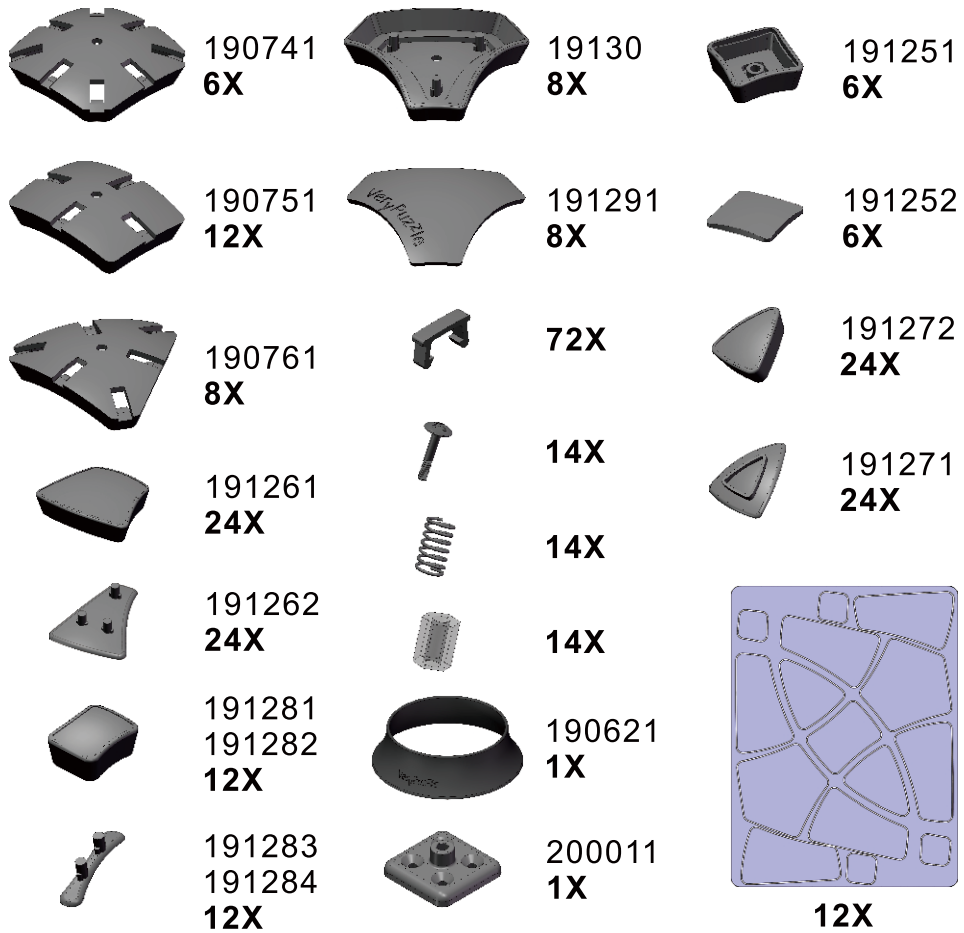

Customer Service

1. support@verypuzzle.com



VeryPuzzle